

SPECIFICATION

COMMERCIALY AVAILABLE

ITEM: CRYSTAL RESONATOR
PART NUMBER: XN-334

Revision Made: Added Marking

ISSUED / REVISION	ENGINEER APPROVED	DOCUMENT CHECKED	DRAFTSMAN	DOCUMENT CHECKED
3/26/10 DS	3/29/2010 SRJ			
4/6/10 DS	4/6/2010 SRJ	4/7/2010 BF	6/18/2010 GIL	

FILTRONETICS Inc

1. Part Number: XN-334

2. Description: A 27 MHz quartz crystal resonator in a HC-49 short surface mount package using fundamental crystals. Height 4.4 mm.

3. Electrical Specifications:

Model	F494H		
Height (H)	4.4 mm standard		
Frequency	27 MHz		
Crystal Cut	AT		
Mode of Oscillation	Fundamental		
Frequency Tolerance at 25°C	+/- 10 ppm max		
Temp stability	+/- 15 ppm -40 to +85° C		
Shunt Capacitance (Co)	7.0 pF Max		
Load Capacitance (Cl)	8 pf		
Aging	±1 to ±5ppm per year		
Insulation Resistance	500 MΩ min @ 100 Vdc		
Drive Level	100 uW Typical, 1000 u W max		
Storage Temperature	-40 to +85°C		
Equivalent Series Resistance	Frequency (MHz)	Mode	ESR (ohms)
	27	FUND	40

5. Mechanical Package: (mm)

Marking:

XN-334 YY/MM

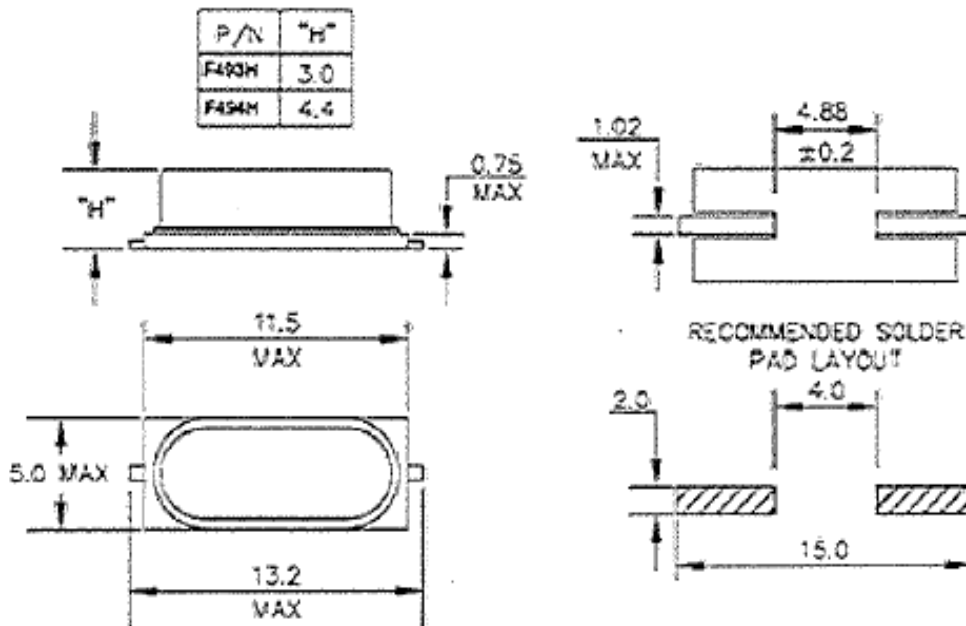

Drawing subject to change with out notice