

SPECIFICATION

ITEM: LC BAND PASS FILTER
 PART NUMBER: FN-4673W

ISSUED / REVISION	ENGINEER APPROVED	DOCUMENT CHECKED	DRAFTSMAN
10/25/2019 ^(PG)	11/26/2019 ^(TG)	10/28/2019 ^(JE)	11/26/2019 ^(PG)

FILTRONETICS Inc

1. Part Number: FN-4673W

2. Electrical Specifications:

Filter Type	LC Band Pass	
Center Frequency (Fo)	312.5 MHz	
3 dB Band Width:	175 MHz Min	
Insertion Loss:	1.5 dB Max	
Pass Band Ripple:	1 dB Max	
Attenuation:	At 174 MHz	45 dB Min
	At 451 MHz	30 dB Min
	At 960 MHz	30 dB Min
Input Power:	0 dBm Max	
Impedance:	50 Ohms	
Operating Temperature:	- 20°C to +85°C	
Workmanship:	J-STD-001	

3. Mechanical Package Example Styles:

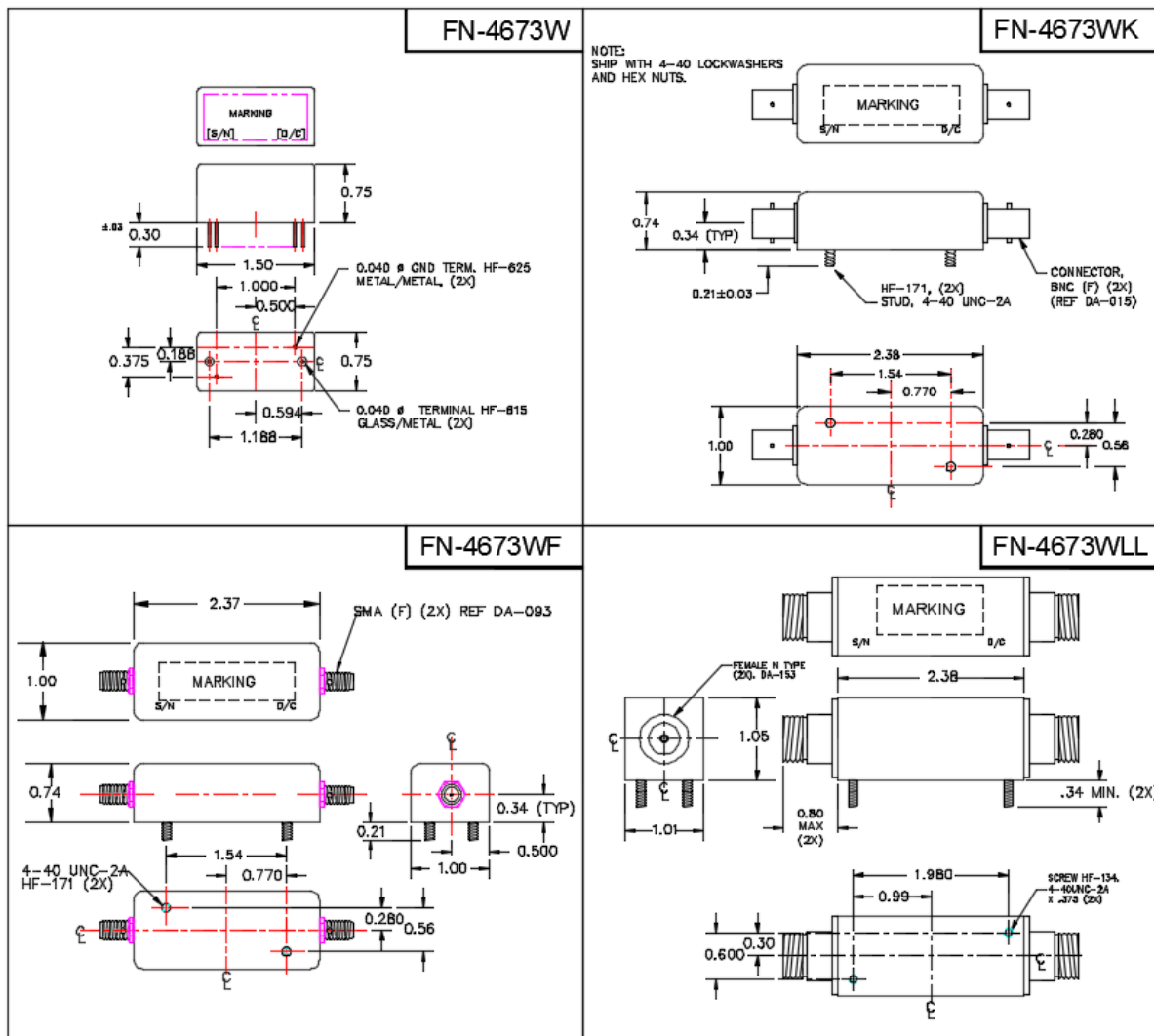

4. Theoretical Response Plot:

