

HIGH POWER LOWPASS FILTER

Fc: 626 MHz
PASS BAND: 486 to 626 MHz
PASS BAND INSERTION LOSS: 0.5 dB MAXIMUM
PASS BAND RETURN LOSS: 14 dB MINIMUM
PASS BAND GROUP DELAY VARIATION: 4 nSEC MAXIMUM
STOP BAND ATTENUATION: 40 dBc MIN ABOVE 972 MHz
STOP BAND ATTENUATION: 70 dBc MIN UP TO 2 GHz
PASS BAND POWER: 100 WATTS RMS
IMPEDANCE: 50 OHMS (IN & OUT)
OPERATING TEMPERATURE: -40°C TO +85°C

FN-3815W

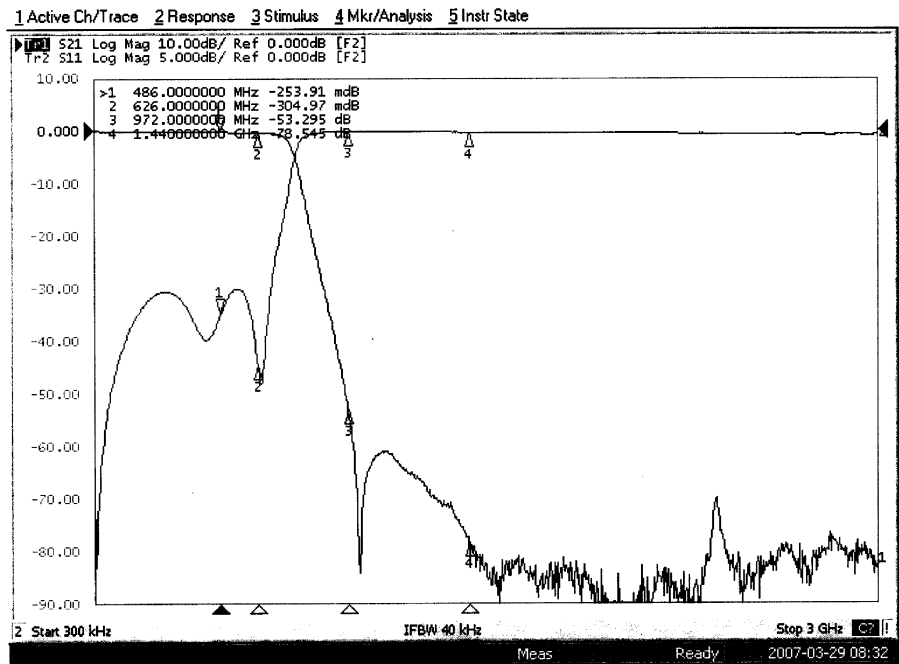
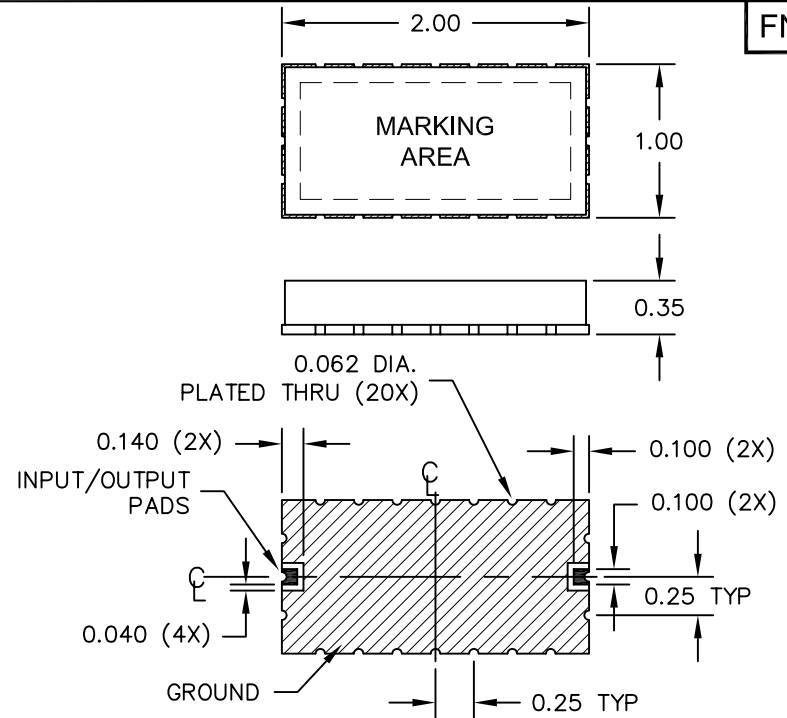

FN-3815W DRAWING SUMMARY

FILTRONETICS, INC.

6010 PARRETTA DR.
 KANSAS CITY, MO 64120
 816-231-7375
 FAX 816-241-0368
 WWW.FILTRO.NET

TOLERANCES UNLESS NOTED

ANGLE = ± 1°	HOLES
.XX = ± .020	± .002
.XXX = ± .010	

REVISED 4/12/2007