

SPECIFICATION
COMMERCIALY AVAILABLE

CERAMIC BAND PASS
 PART NUMBER: CF-25300606
 NPT

ISSUED	CHECKED	CHECKED	CHECKED
11/19/07 **	10/4/2010 SRJ	10/5/2010 BF	10/7/2010 GL
	09/13/2013 TFG		09/13/2013 GL

FILTRONETICS Inc

1. APPLICATION

THIS SPECIFICATION APPLIES TO BAND PASS FILTER, USING DIELECTRIC RESONATORS.

2. PART NUMBER

PART NO	CF-25300606
PACKAGING	PLASTIC TRAY

3. SPECIFICATIONS

NO	ITEMS	Ref.	SPECIFICATION
1	Center Frequency (Fo)	a1	2530 MHz
2	1.0 dB Band Width (=PB)	b1	60 MHz Min
3	Insertion Loss AT Fo	a1	4.3 dB Max
4	V.S.W.R IN Fo+/-30 MHz		1.75:1 Min
5	Attenuation [absolute value]	At 2460 MHz	23 dB Min
		At 2620 MHz	33 dB Min
6	Impedance	-	50Ω
7	Maximum Input Power	-	1 W (+30 dBm)
8	Operating Temperature Range	-	-35 ~ +85°C
9	Workmanship	-	IPC-610 class 3
10	Process Temperature	-	+150°C for 1 hour or +230°C for 10 minutes

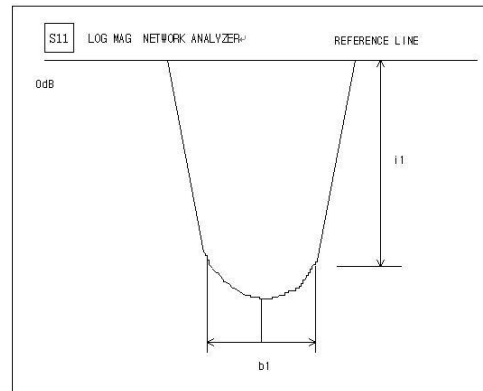
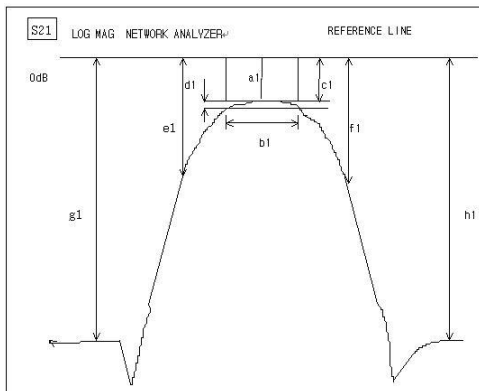

4. GRAPHS:

S21 vs S11 (INSERTION LOSS, RETURN LOSS, V.S.W.R, SMITH CHART)

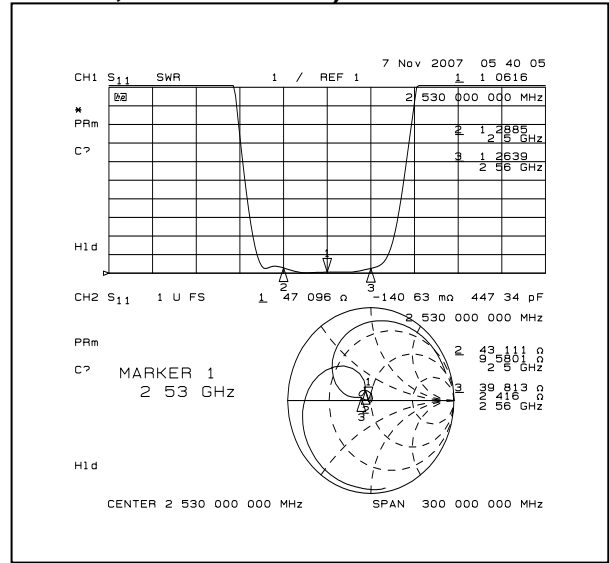
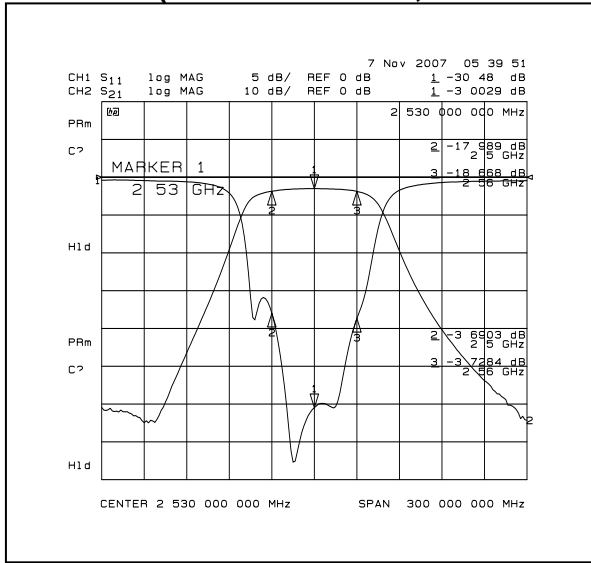

S21 (ATTENUATION, 1dB BAND WIDTH)

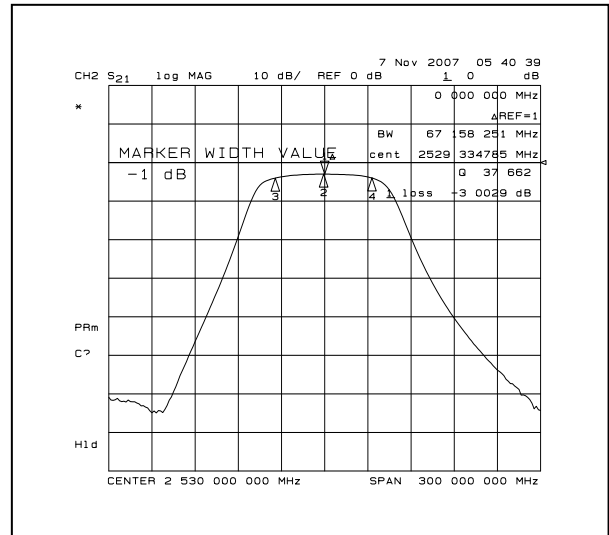
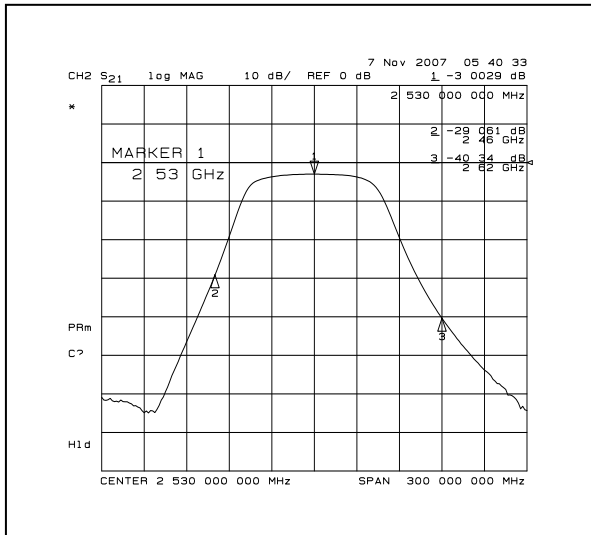

S21 (OUT BAND ATTENUATION) Changed Nov 22, 2007

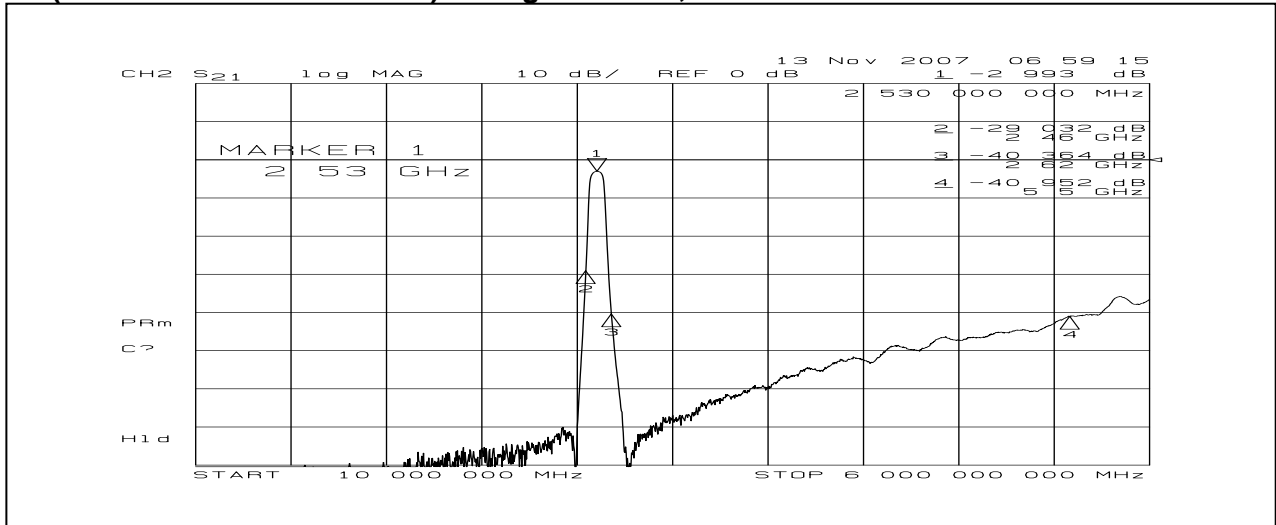

5. DIMENSIONS:

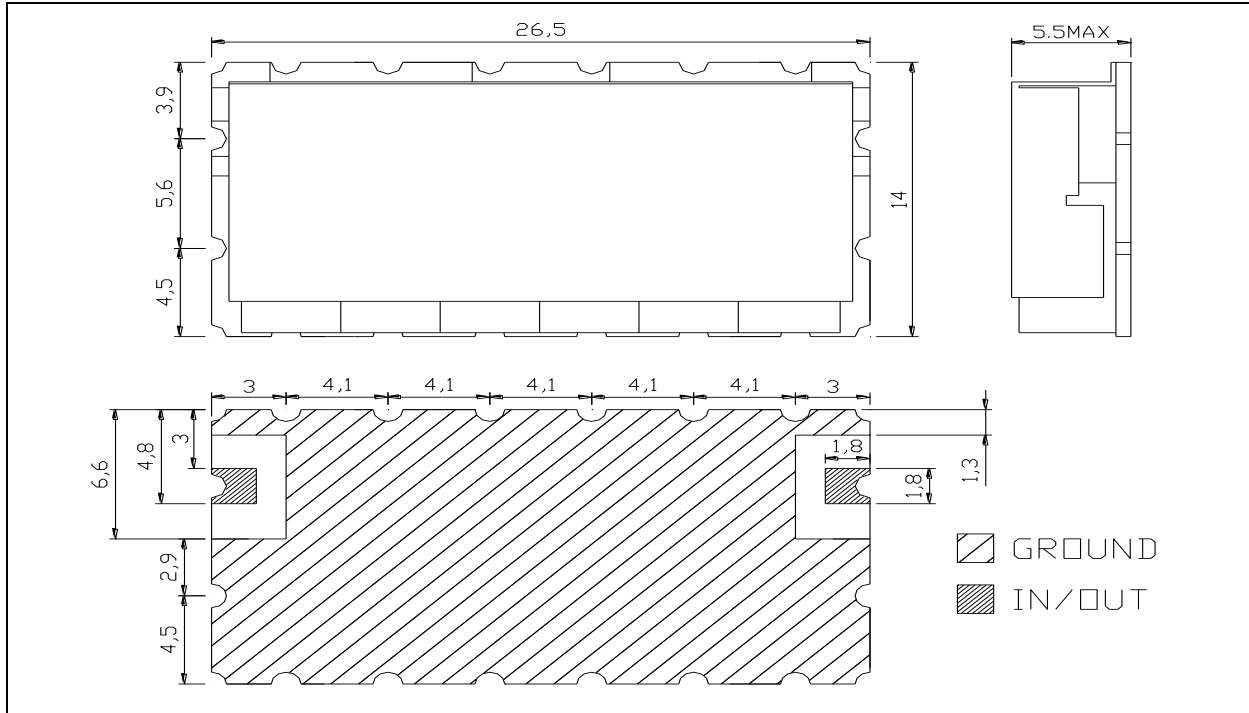

MATERIAL SPECIFICATION

1. PCB
 - 1) MATERIAL: FR4
 - 2) TERMINALS: Sn/Pb, HASL,
2. METAL CASE
 - 1) Ag plated brass
3. RESONATOR
 - 1) COATING MATERIAL: silver plate, 8~30um
4. INTERNAL SOLDER
 - 1) Sn96.5/Ag3.5 Lead Free solder, 221 deg C melting
5. RESONATORS TABS
 - 1) Sn/Pb(9:1) Plated brass (Can not be pure Tin)
Or Ag Plates
6. NO PURE TIN ALLOWED

MARKING

Label Material: High temp polyimide
 Marking:
 CF-25300606
 Filtronetics, Inc
 Date Code
 Customer P/N
 UNIT: MM
 TOLERANCE: +/-0.5MM
 IN/OUT LAND: +/-0.3MM

CAUTIONS:

1. When handling products, be careful not to damage the outer-electrode.
2. When handling products be careful not to touch the outer-electrode with bare hands or solderability is reduced.
3. Do not apply excessive pressure or shock to product in handling or in transportation or damage to the ceramic filters may result.

Recommended Solder Pattern:

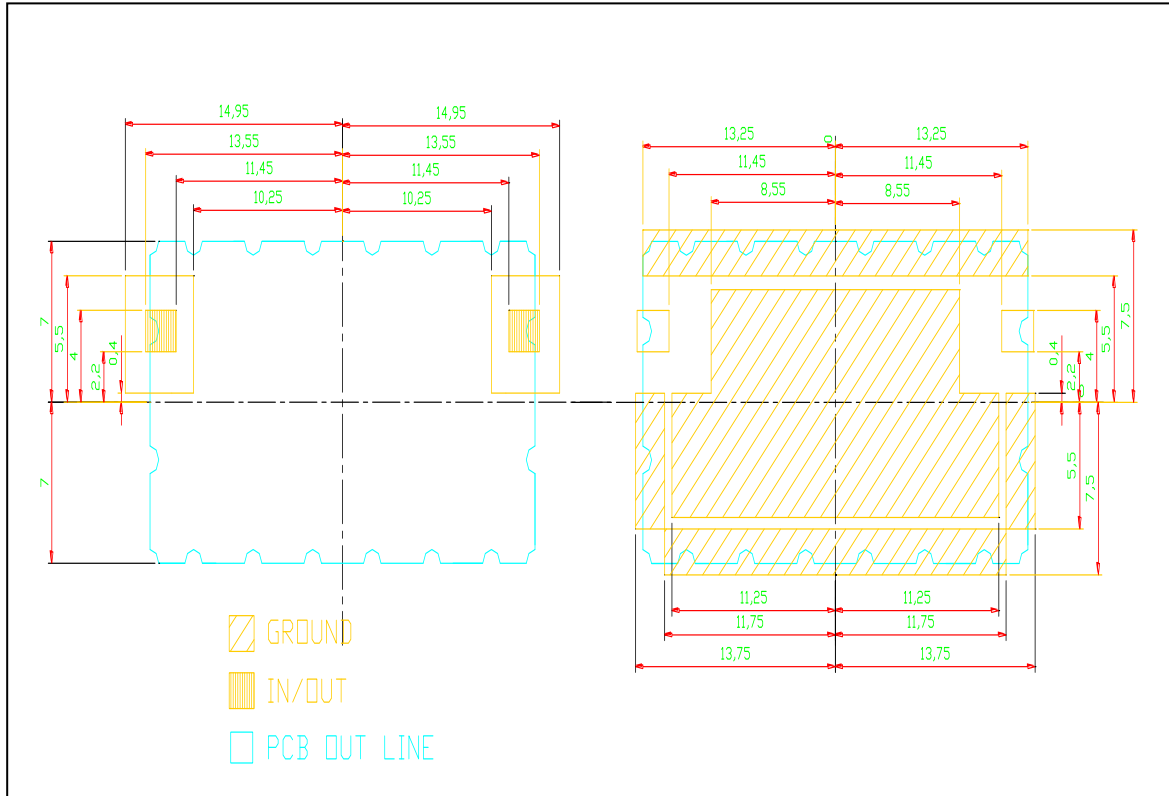

Quality Conformance Test 100% Final inspection 100% Test Data	
1)	Visual mechanical to IPC-610 Class 3 Including inspection for cleanliness.
2)	Thermal Shock -44 to +85°C 10 cycles
3)	Electrical Specifications at ambient

6. DEFINITIONS:

TERMS	DESCRIPTION	SPECIFICATION
Center Frequency	The midpoint of through band pass filter pass band, normally expressed as the arithmetic mean of the -3dB point. Also called Fo.	3. SPECIFICATION
Pass Band Width	The width of the pass band of a filter referenced to the minimum insertion loss point in the pass band. The pass band of a filter is stated as -1.0dB bandwidth.	
Insertion Loss	The loss of the filter, in db, measured at center frequency relative to a through line (0 dB).	
Attenuation	Reduction of RF power through a filter measured in dB, at desired band and referenced to 0 dB. (Filter to be removed from circuit)	
Pass Band Ripple	Variations in loss in the pass band of the filter, superimposed upon the fundamental shape of the pass band.	
V.S.W.R in Pass Band	The ratio of the maximum value of a standing wave to its minimum value, related to the return loss in pass band.	
Date Code	Each date code shall be from a single lot	
Lot	One Batch of parts processed in a single manufacturing run. A single lot shall have no more than one firing, plating, soldering, or other batch processing.	
Cleanliness	Parts shall be clean. They shall be free from smudges, loose solder, solder spatter, metal chips or mold release agents. No burrs. Particles or any foreign material over 0.2 mm which might detract from the intended operation, function or appearance of the part.	

7. REFLOW SOLDERING STANDARD CONDITIONS FOR TIN/LEAD

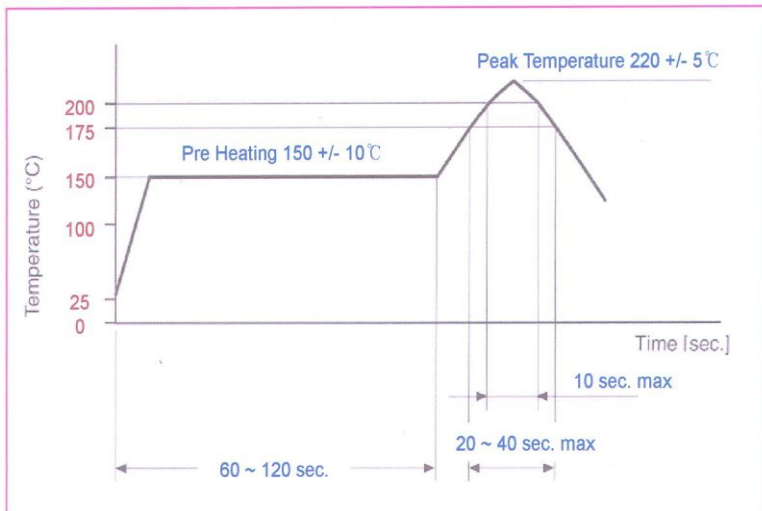

- Measuring point of temperature in-out terminals of the device.
- Reflow Soldering
- Both convection and infrared rays
- Hot air
- Hot plates
- Solder Cream: Sn64/Pb36

8. RELIABILITY TEST AND CONDITIONS

ITEM	TEST CONDITIONS	REQUIREMENTS
Resistance to solder heat	Preheat temperature : 120 to 150°C Preheat time: 1 to 1.5 min Solder temperature: 260 +/- 10°C Dipping time: 10 +/- 0.5 sec →Soldering Time : 5sec.max.per each terminal	No damage such as cracks should be caused in chip element.
Solderability	Preheat temperature: 120 to 150°C Preheat time: 1 to 1.5 min Solder temperature: 235 +/- 5°C Dipping time: 5 +/- 1 sec	More than 80% of the terminal electrode shall be covered with new solder
Heat resistance (High-temperature Load)	Temperature: 85 +/- 2°C Applied voltage: Rated voltage Applied current: Rated current Recovery: 1 to 2hrs of recovery under the standard condition after the removal from test chamber.	No mechanical damage. After test, the device shall satisfy the specification in section 3. Standard condition is 25+/-5°C and Less than 65% relative humidity
Thermal shock (Temperature cycle)	Conditions for 1 cycle Step 1: + 85°C 15 min Step 2 : - 44°C 15 min Number of cycle: 10	No mechanical damage. After test, the device shall satisfy the specification in section 3.
Humidity Resistance	Temperature: 40 +/- 2°C Humidity: 90 to 95% RH Duration: 96 +/- 5 hrs Recovery: 1 to 2hrs of recovery under the standard condition after the removal from test chamber.	No mechanical damage. After test, the device shall satisfy the specification in section 3.
Vibration	The device is subjected to vibration of 2sweeps in each of three mutually perpendicular planes. Frequency shall be varied within 10~50Hz with 1.5mm double amplitude and within 50~500 Hz With 10G's acceleration. Sweep time of Frequency Shall be 15minutes.	No mechanical damage. After test, the device shall satisfy the specification in section 3.
Shock	The device is subjected to 3 shocks in each direction of six mutually perpendicular plenes. Each shock shall be a half-sine wave shaped with a magnitude of 30G's and a duration of 11msec.	No mechanical damage. After test, the device shall satisfy the specification in section 3.