

SPECIFICATION

ITEM: DIELECTRIC CERAMIC FILTER
PART NUMBER: CF-18800603

Revision Made:

ISSUED	CHECKED	CHECKED	CHECKED
10/24/06 **	10/4/2010 SRJ	10/5/2010 BF	10/7/2010 GL

FILTRONETICS Inc

1. APPLICATION

THIS SPECIFICATION APPLIES TO BAND PASS FILTER USING DIELECTRIC RESONATORS.

2. PART NUMBER

PART NO	CF-18800603
PACKAGING	PLASTIC TRAY

3. SPECIFICATIONS

NO	ITEMS	Ref.	SPECIFICATION
1	Center Frequency (Fo)	-	1880 MHz
2	Pass Band Width (= PB)	-	Fo+/-30 MHz
3	Insertion Loss IN PB	-	2.4 dB Max
4	Ripple IN PB	-	0.8 dB Max
5	ATTENUATION (absolute Value)	AT 1760 MHz	24 dB Min
		AT 2000 MHz	20 dB Min
6	Return Loss IN PB	-	15 dB Min
7	Impedance	-	50Ω
8	Maximum Input Power	-	1 W (+30 dBm)
9	Operating Temperature Range	-	-30 - +85°C

S21 LOG MAG NETWORK ANALYZER

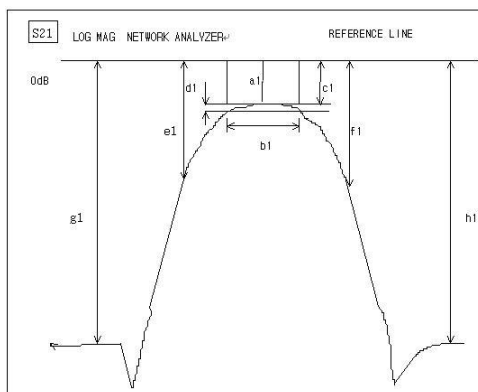

S11 LOG MAG NETWORK ANALYZER

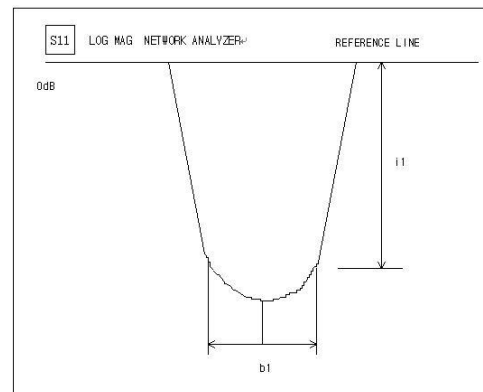

4. GRAPHS

S21 vs. S11 (INSERTION LOSS, RETURN LOSS, V.S.W.R, Smith Chart)

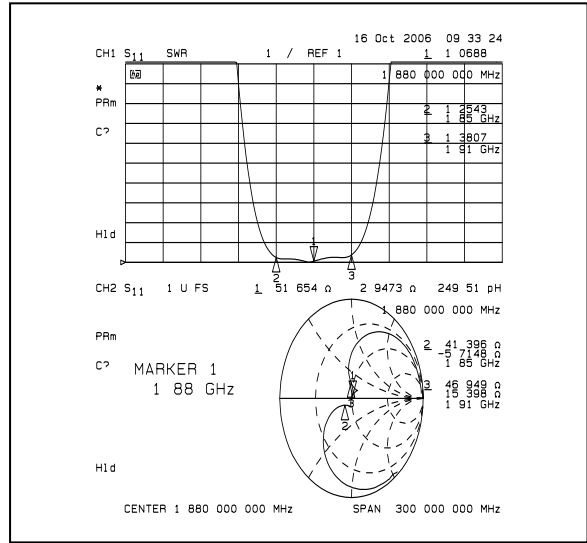
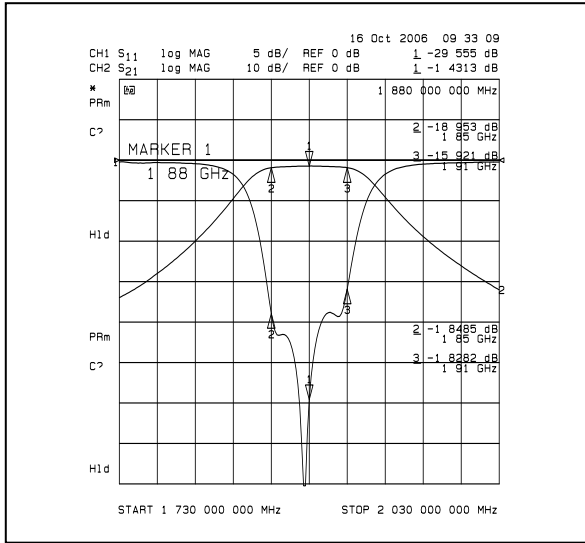

S21 (ATTENUATION, RIPPLE)

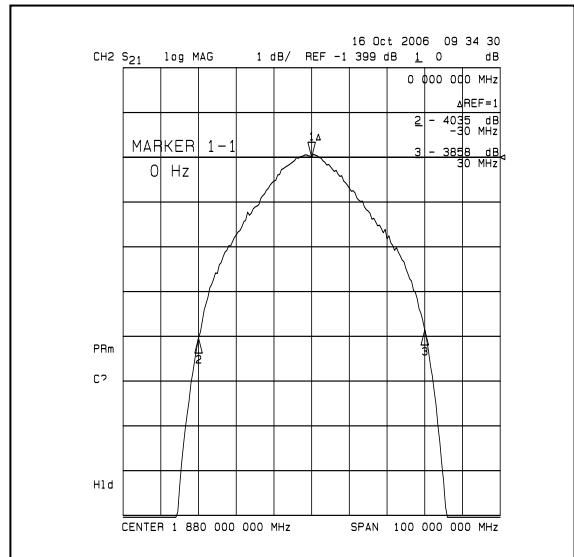
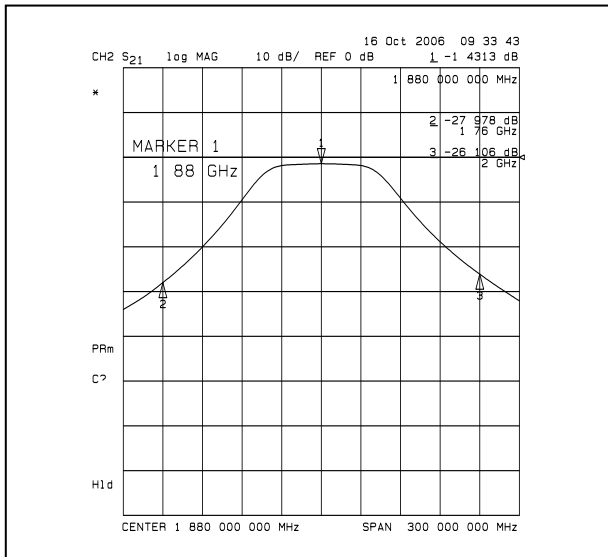

5. DIMENSIONS:

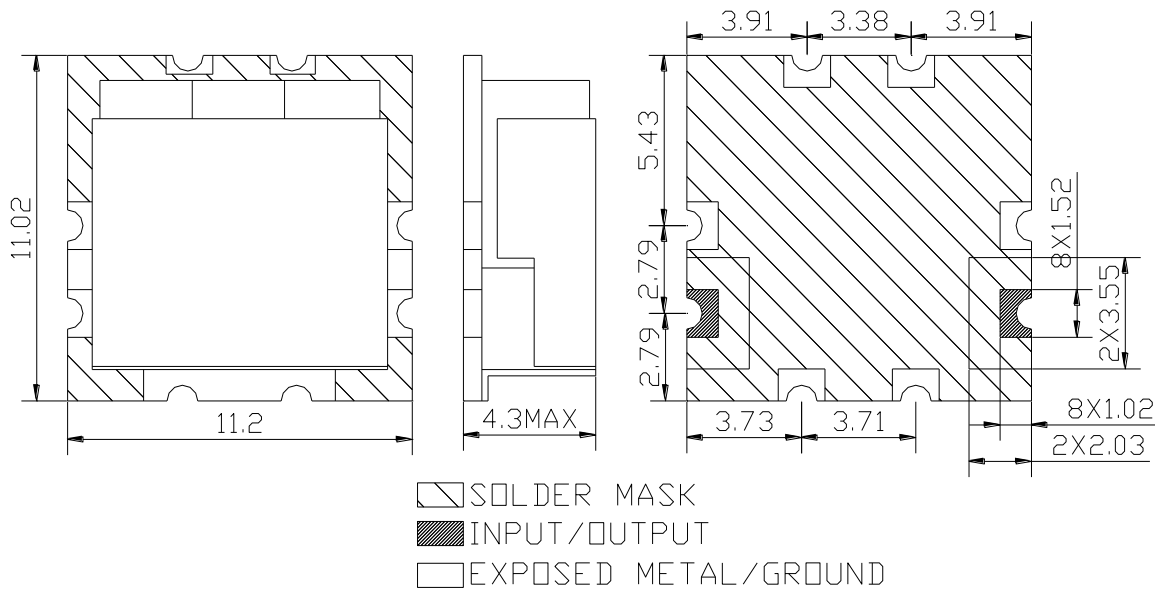

MATERIAL SPECIFICATION	
1.	PCB
1)	MATERIAL: FR4
2)	TERMINALS: Au PLATED
2.	METAL CASE
1)	MATERIAL: Sn OR Ni PLATED
3.	RESONATOR
1)	COATING MATERIAL: Ag
4.	ROHS Compliant

MARKING	
CF-18800603	
Filtronetics, Inc	
Date Code	
UNIT: MM	
TOLERANCE: +/-0.5MM	
IN/OUT LAND: +/-0.3MM	

● CAUTIONS:

1. When handling products, be careful not to damage the outer-electrode.
2. When handling products be careful not to touch the outer-electrode with bare hands or solderability is reduced.
3. Do not apply excessive pressure or shock to product in handling or in transportation or damage to the ceramic filters may result.

6. DEFINITIONS:

TERMS	DESCRIPTION	SPECIFICATION
Center Frequency	The midpoint of through band pass filter pass band, normally expressed as the arithmetic mean of the -3dB point. Also called Fo.	3. SPECIFICATION
Pass Band Width	The width of the pass band of a filter referenced to the minimum insertion loss point in the pass band. The pass band of a filter is stated as -1.0dB bandwidth.	
Insertion Loss	The loss of the filter, in db, measured at center frequency relative to a through line (0 dB).	
Attenuation	Reduction of RF power through a filter measured in dB, at desired band and referenced to 0 dB. (Filter to be removed from circuit)	
Pass Band Ripple	Variations in loss in the pass band of the filter, superimposed upon the fundamental shape of the pass band.	
V.S.W.R in Pass Band	The ratio of the maximum value of a standing wave to its minimum value, related to the return loss in pass band.	

7. RELIABILITY TEST AND CONDITIONS:

ITEM	TEST CONDITIONS	REQUIREMENTS
Resistance to solder heat	Preheat temperature : 120 to 150°C Preheat time: 1 to 1.5 min Solder temperature: 260 +/- 10°C Dipping time: 10 +/- 0.5 sec	No damage such as cracks should be caused in chip element.
Solderability	Preheat temperature: 120 to 150°C Preheat time: 1 to 1.5 min Solder temperature: 235 +/- 5°C Dipping time: 5 +/- 1 sec	More than 80% of the terminal electrode shall be covered with new solder
Heat resistance (High-temperature Load)	Temperature: 85 +/- 2°C Applied voltage: Rated voltage Applied current: Rated current Recovery: 1 to 2hrs of recovery under the standard condition after the removal from test chamber.	No mechanical damage. After test, the device shall satisfy the specification in section 3.
Thermal shock (Temperature cycle)	Conditions for 1 cycle Step 1: + 85°C 15 min Step 2 : - 30°C 15 min Number of cycle: 10	No mechanical damage. After test, the device shall satisfy the specification in section 3.
Humidity Resistance	Temperature: 40 +/- 2°C Humidity: 90 to 95% RH Duration: 96 +/- 5 hrs Recovery: 1 to 2hrs of recovery under the standard condition after the removal from test chamber.	No mechanical damage. After test, the device shall satisfy the specification in section 3.
Vibration	Frequency: 10 ~ 50 Hz Amplitude: 1.52 mm (0.060 inches) Direction: X, Y and Z Time: each 30 min for all directions	No mechanical damage. After test, the device shall satisfy the specification in section 3.

8. REFLOW SOLDERING STANDARD CONDITIONS

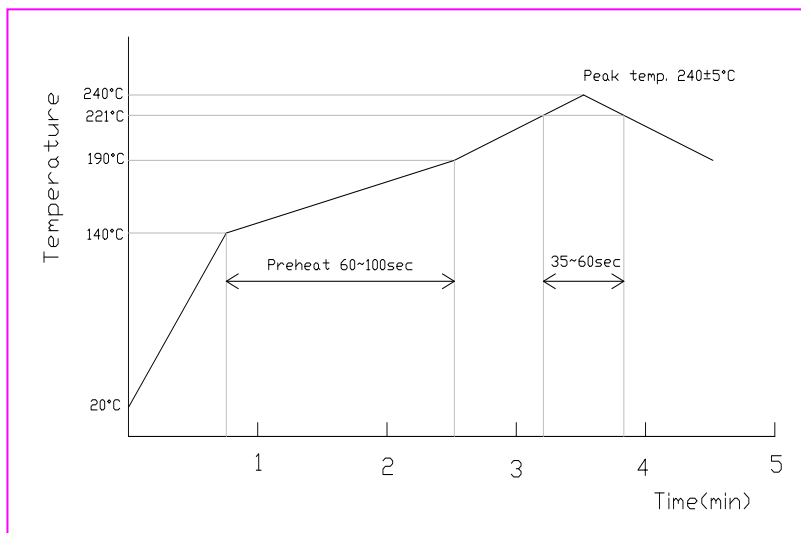

- Measuring point of temperature in-out terminals of the device.
- Reflow Soldering
- Both convection and infrared rays
- Hot air
- Solder Cream: Sn96.5/Ag3.5