

SPECIFICATION

COMMERCIALY AVAILABLE

CERAMIC BAND PASS FILTER
 PART NUMBER: CF-10230366A
 NPT / FOD

See FNP-1506SQ for hermetically sealed.

ISSUED / REVISION	ENGINEER APPROVED	DOCUMENT CHECKED	DRAFTSMAN	DOCUMENT CHECKED
06/11/2020 ^(ASM)				

FILTRONETICS Inc

1. APPLICATION

THIS SPECIFICATION APPLIES TO A BAND PASS FILTER, USING DIELECTRIC RESONATORS.

2. PART NUMBER: CF-10230366A

3. SPECIFICATIONS:

ITEMS		Ref.	SPECIFICATION
Center Frequency (Fo)		-	1023 MHz
Pass Bandwidth (=PB)		-	Fo+/-18 MHz (1005~1041MHz)
Insertion Loss at Fo+/-18MHz		-	3.0 dB Max
Ripple at Fo+/-18MHz		-	1.0 dB Max
Attenuation [Absolute Value]	DC-970MHz		20.0 dB Min, 30dB Typ.
	1075~2400MHz		20.0 dB Min, 30dB Typ
Return Loss	IN PB	-	12 dB Min
Impedance		-	50 Ω
Maximum Input Power		-	1 W (+30 dBm)
Operating Temperature Range		-	- 30°C to +75°C
Processing Temp		-	+150°C for 1 hour Or +230°C for 10 minutes

S21 LOG MAG NETWORK ANALYZER

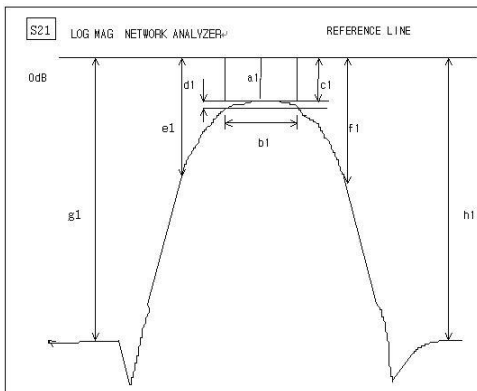

S11 LOG MAG NETWORK ANALYZER

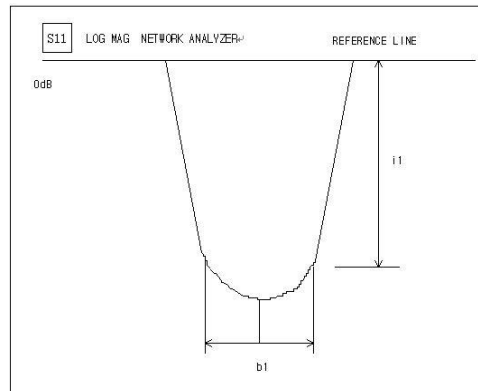

● **CAUTIONS:**

1. When handling products, be careful not to damage the outer-electrode.
2. When handling products be careful not to touch the outer-electrode with bare hands or solder-ability is reduced.
3. Do not apply excessive pressure or shock to product in handling or in transportation or damage to the ceramic filters may result.

Quality Conformance Test 100% Final inspection 100% Test Data	
1)	Visual mechanical to IPC-610 Class 2 Including inspection for cleanliness.
2)	Thermal Shock -44 to +85°C 10 cycles
3)	Electrical Specifications at ambient

5. THEORETICAL RESPONSE:

S21 vs S11 (INSERTION LOSS, RETURN LOSS, V.S.W.R, SMITH CHART)

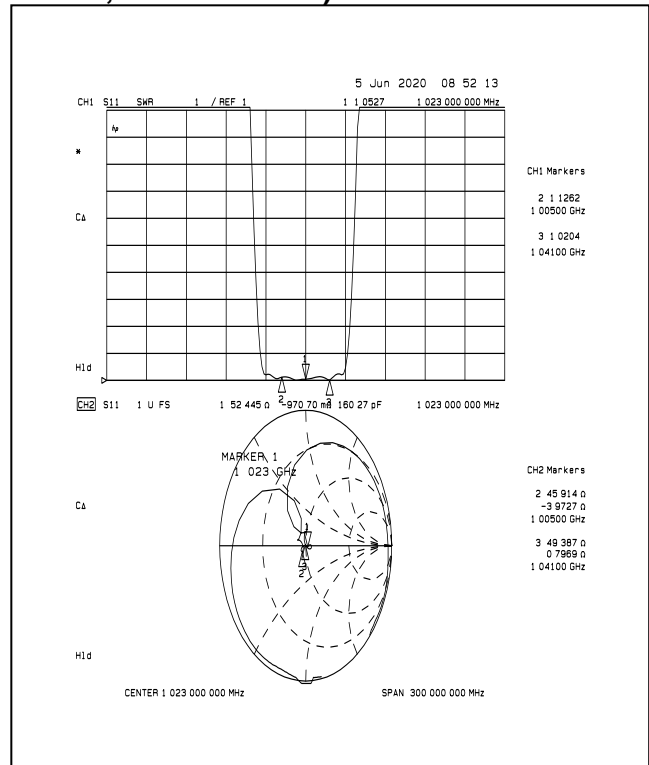
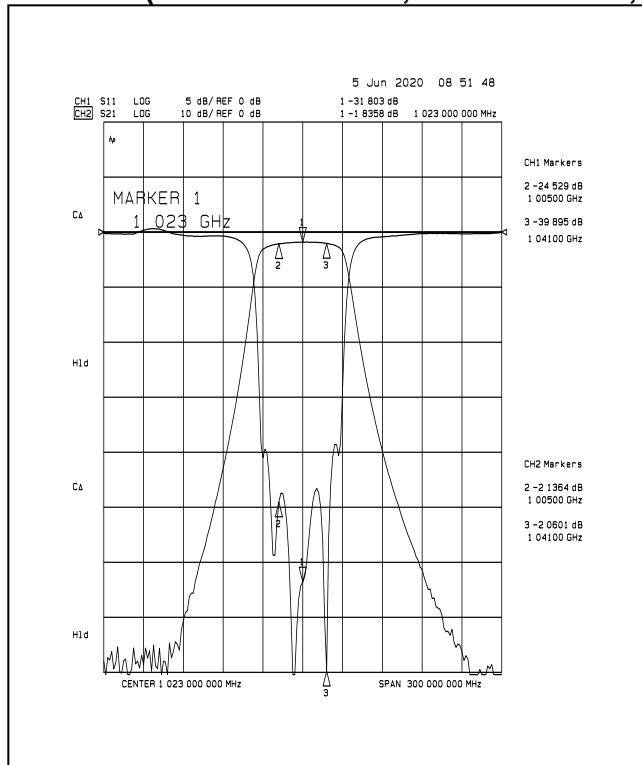

S21(1.0DB BAND WIDTH, ATTENUATION)

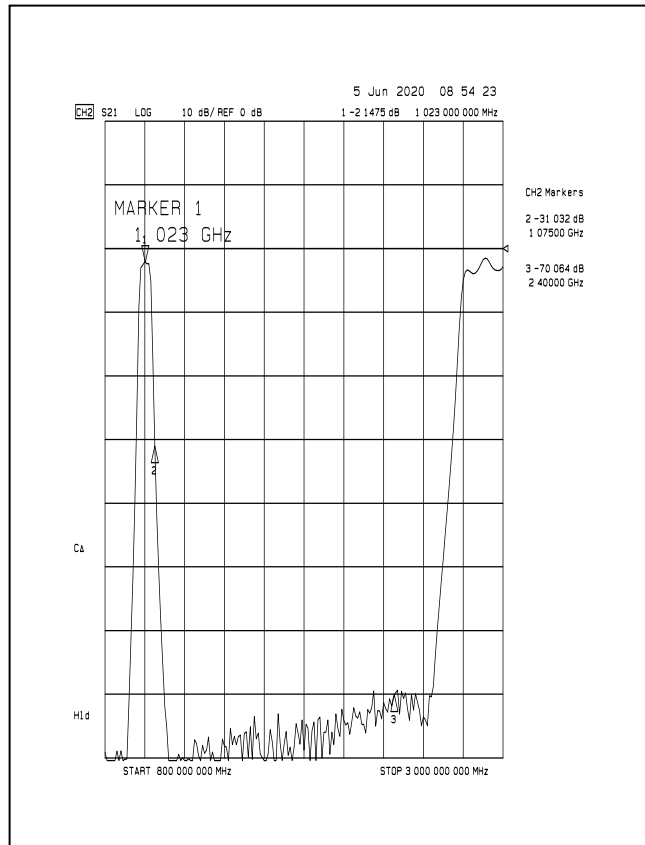
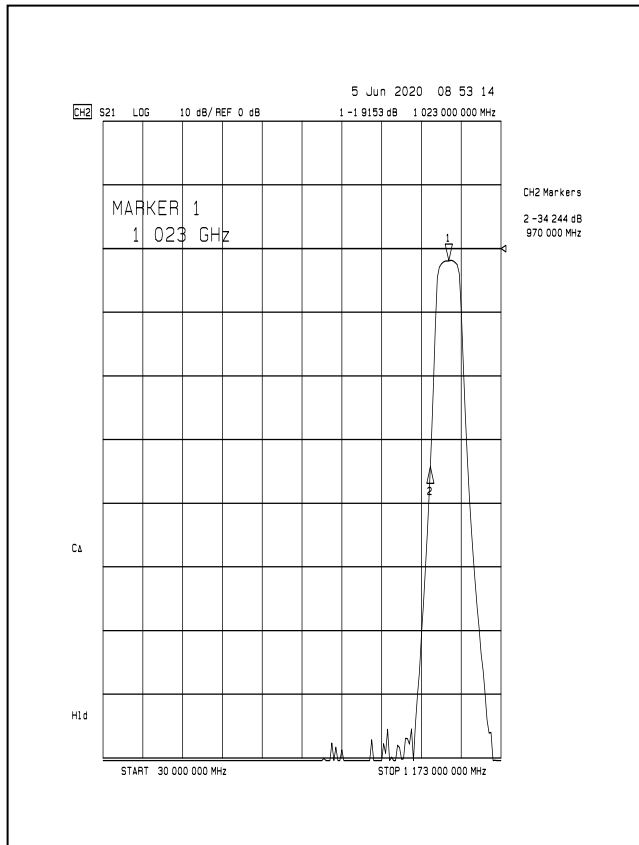

6. DEFINITIONS:

TERMS	DESCRIPTION	SPECIFICATION
Center Frequency	The midpoint of through band pass filter pass band, normally expressed as the arithmetic mean of the -3db point. Also called fo.	3. SPECIFICATION
Pass Band Width	The width of the pass band of a filter referenced to the minimum insertion loss point in the pass band. The pass band of a filter is stated as -1.0dB bandwidth.	
Insertion Loss	The loss of the filter, in db, measured at center frequency relative to a through line (0 dB).	
Attenuation	Reduction of RF power through a filter measured in dB, at desired band and referenced to 0 dB. (Filter to be removed from circuit)	
Pass Band Ripple	Variations in loss in the pass band of the filter, superimposed upon the fundamental shape of the pass band.	
V.S.W.R in Pass Band	The ratio of the maximum value of a standing wave to its minimum value, related to the return loss in pass band.	

7. RELIABILITY TEST AND CONDITIONS:

ITEM	TEST CONDITIONS	REQUIREMENTS
Resistance to solder heat	Preheat temperature : 120 to 150°C Preheat time: 1 to 1.5 min Solder temperature: 260 +/- 10°C Dipping time: 10 +/- 0.5 sec	No damage such as cracks should be caused in chip element.
Solderability	Preheat temperature: 120 to 150°C Preheat time: 1 to 1.5 min Solder temperature: 235 +/- 5°C Dipping time: 5 +/- 1 sec	More than 80% of the terminal electrode shall be covered with new solder
Heat resistance (High-temperature Load)	Temperature: 85 +/- 2°C Applied voltage: Rated voltage Applied current: Rated current Recovery: 1 to 2hrs of recovery under the standard condition after the removal from test chamber.	No mechanical damage. After test, the device shall satisfy the specification in section 3.
Thermal shock (Temperature cycle)	Conditions for 1 cycle Step 1: + 85°C 15 min Step 2 : - 30°C 15 min Number of cycle: 10	No mechanical damage. After test, the device shall satisfy the specification in section 3.
Vibration	Frequency: 10 ~ 50 Hz Amplitude: 1.52mm (0.060 inches) Direction: X, Y and Z Time: each 30 min for all directions	No mechanical damage. After test, the device shall satisfy the specification in section 3.

8. REFLOW SOLDERING STANDARD CONDITIONS FOR TIN/LEAD

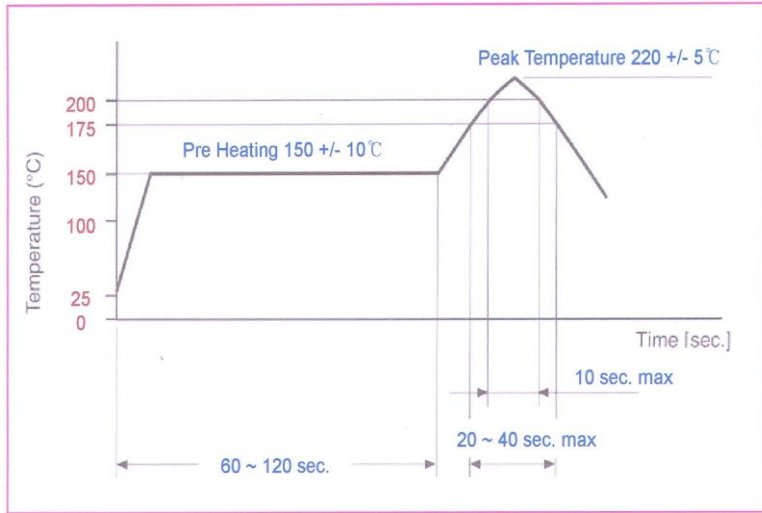

- Measuring point of temperature in-out terminals of the device.
- Reflow Soldering
- Both convection and infrared rays
- Hot air
- Hot plates
- Solder Cream: Sn64/Pb36