

BANDPASS FILTER

Fo: 65.0 MHz
IMPEDANCE : 50 OHMS (IN & OUT)
INSERTION LOSS: 4.0 dB MAX, 3 dB TYPICAL
RIPPLE: 0.75 dB MAX
3dB BANDWIDTH: 50 KHz MIN
60dB BANDWIDTH: 220 KHz MAX
SPURIOUS ATTENUATION: 60 dB MIN
ULTIMATE ATTENUATION: 60 dB MIN
OPERATING TEMPERATURE : -20°C to +75°C

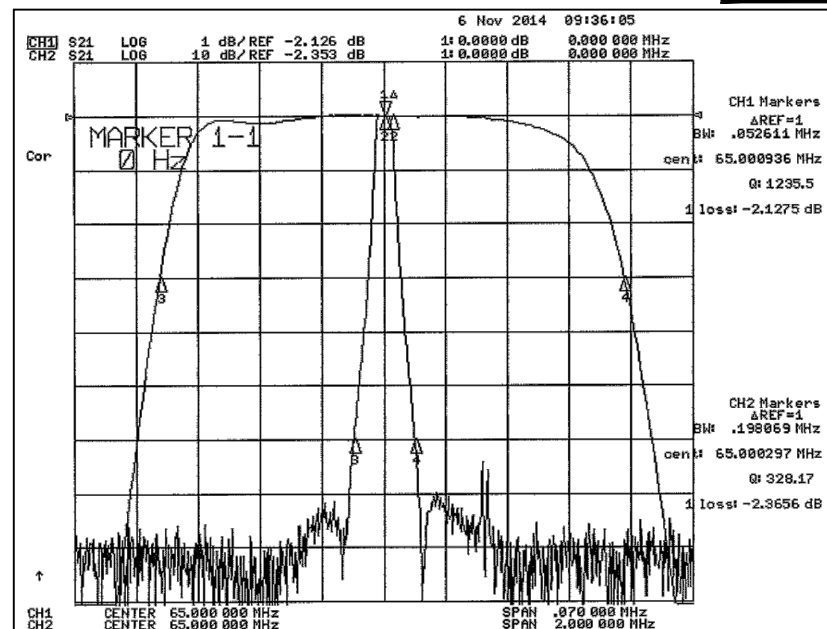

FN-3218WT

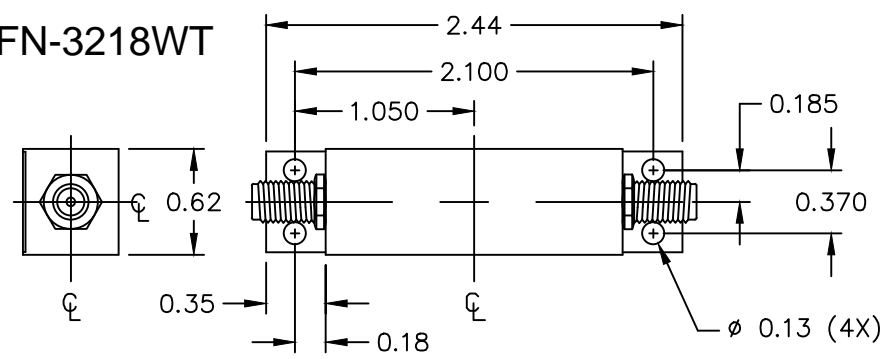

SMA (F) CONNECTOR (2x)

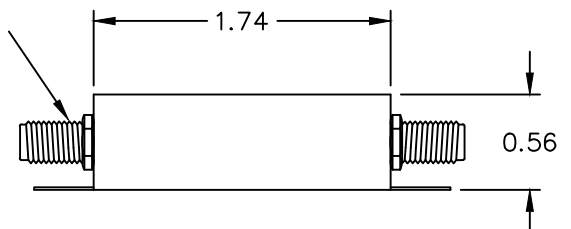

FN-3218W DRAWING SUMMARY SHEET 1 of 2

FILTRONETICS, INC.
 6010 PARRETTA DR.
 KANSAS CITY, MO 64120
 816-231-7375
 FAX 816-241-0368
 WWW.FILTRO.NET

TOLERANCES UNLESS NOTED
 ANGLE = ± 1°
 .XX = ± .020
 .XXX = ± .010
 HOLES ± .002
 REVISED 2/2/06

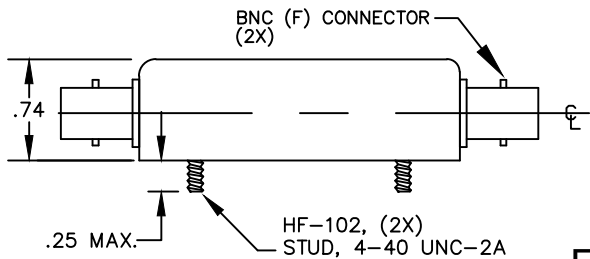

FN-3218WK

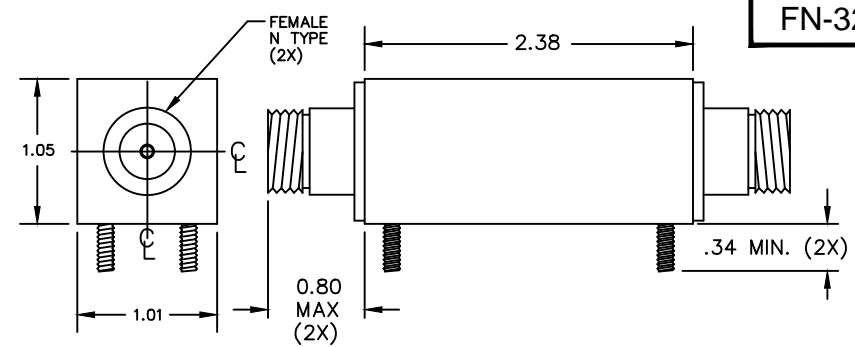
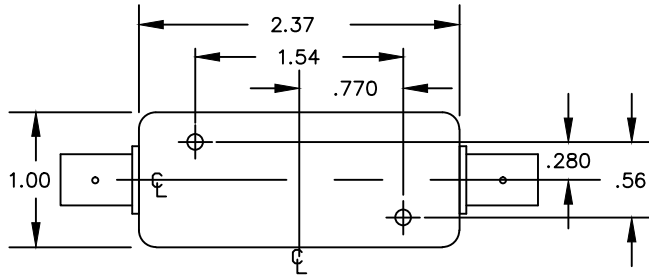

FN-3218W

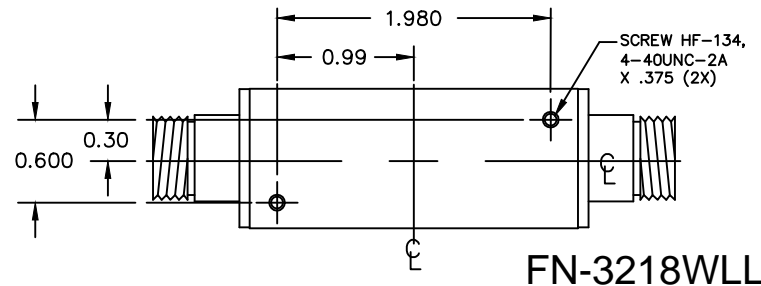

FN-3218WLL

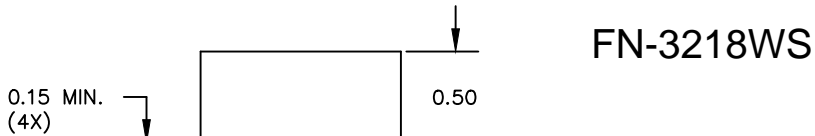

FN-3218WS

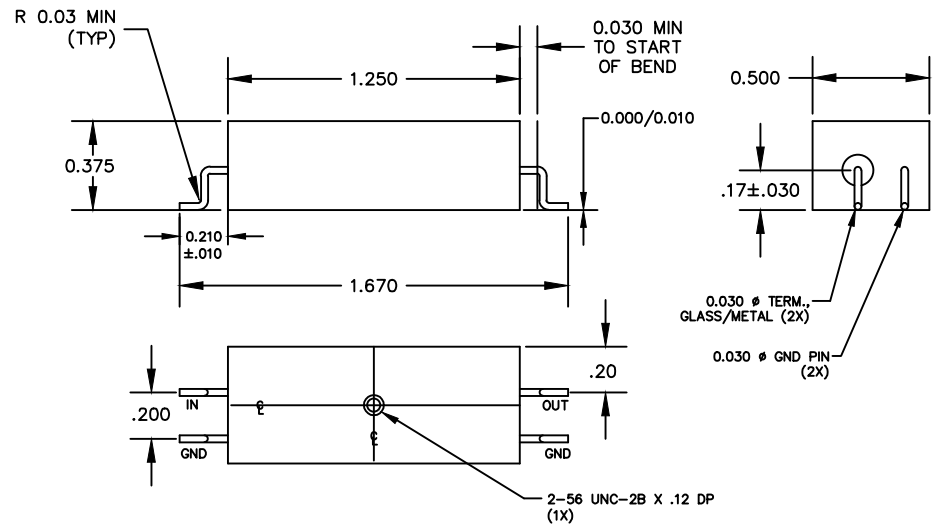
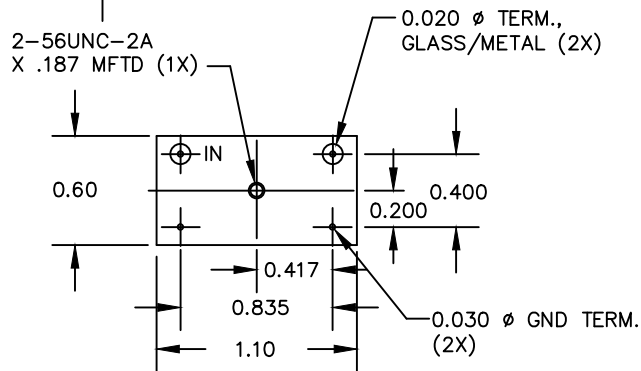

FN-3218WEE

FN-3218W DRAWING SUMMARY SHEET 2 of 2

FILTRONETICS, INC.
 6010 PARRETTA DR.
 KANSAS CITY, MO 64120
 816-231-7375
 FAX 816-241-0368
 WWW.FILTRO.NET

TOLERANCES UNLESS NOTED

ANGLE = ± 1°	HOLES
.XX = ± .020	± .002
.XXX = ± .010	

REVISED 2/2/06